

ML-MC2517XR-18C-B

ML-MC-XR series



Drawing No. A24358

レンズ形式	Lens Type	Macro Lens
光学倍率	Magnification	0.04~0.32
焦点距離 (mm)	Focal Length	25.01
Fno	Fno	1.70~16.00
使用波長域 (nm)	Wavelength range used	400~700
NA	Numerical Aperture	-
WD/OD (mm)	Working/Object Distance	550.0~70.0 / 556.0~76.0
O/I (mm)	Object to Image Distance	629.13~155.94
鏡筒長 (mm)	Mechanical Tube Length	61.60~68.40
レンズバック (mm)	Lens Back	14.67~21.48
被写界深度 (mm)	DOF @PCoC ϕ 0.04mm	75.040~1.764
分解能 (μ m)	Resolution @ λ =550nm	-
前側/後側主点位置 (mm)	Front/Rear Principal Position	26.60 / -11.44
入射/出射瞳位置 (mm)	Entrance/Exit Pupil Position	21.18 / -18.37
入射/出射瞳径 (mm)	Entrance/Exit Pupil Diameter	14.30 / 18.25
画角 (deg.) H×V	Angle Of View @WD=550	19.36 × 14.56(2/3 Inch) 30.58 × 23.16(1.1 Inch) 33.38 × 25.33(1.2 Inch)
TVディストーション (%)	TV Distortion @WD=550	≤ -0.018 (2/3 Inch) ≤ -0.019 (1.1 Inch) ≤ 0.032 (1.2 Inch)
周辺光量比 (%)	Relative Illumination @WD=550	≥ 87.75 (2/3 Inch) ≥ 69.29 (1.1 Inch) ≥ 63.10 (1.2 Inch)
質量 (g)	Weight	208.1
マウント	Mount	C Mount
イメージサークル径 (mm)	Image Circle	ϕ 19.3
最大適合カメラ	Largest Compatible Camera	1.2 Inch

ML-MC2517XR-18C-B

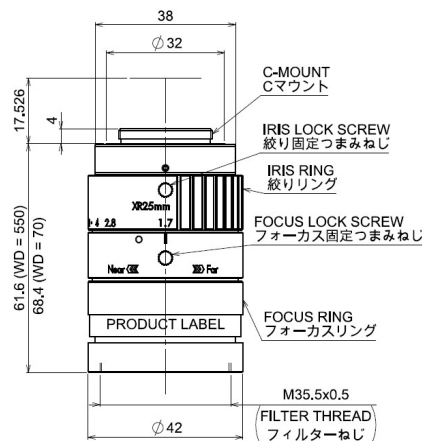

0.04x Fno2.8

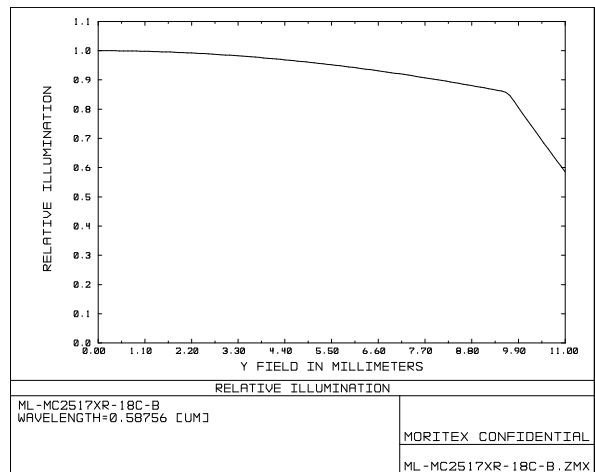
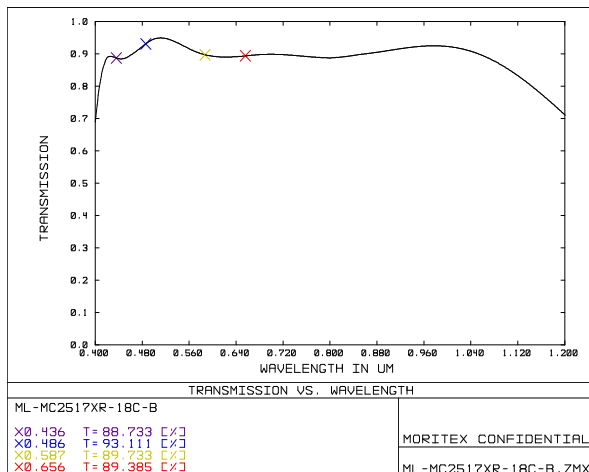
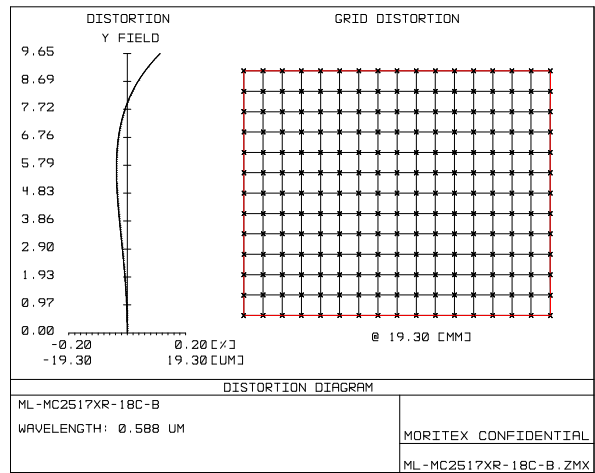
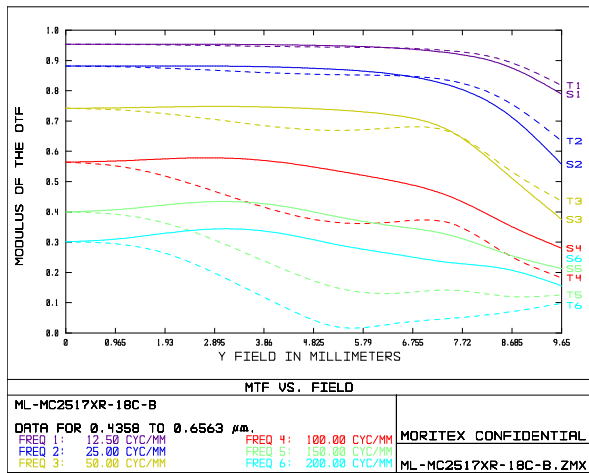

内容は、通知なしに随時変更されることがあります。
 The content is subject to change at any time without notification.

株式会社 **モリテックス** **MORITEX Corporation**

Technology center Lens design & Development technology
 moritex.mvs@moritex.com
 www.moritex.com



0.08x Fno2.8

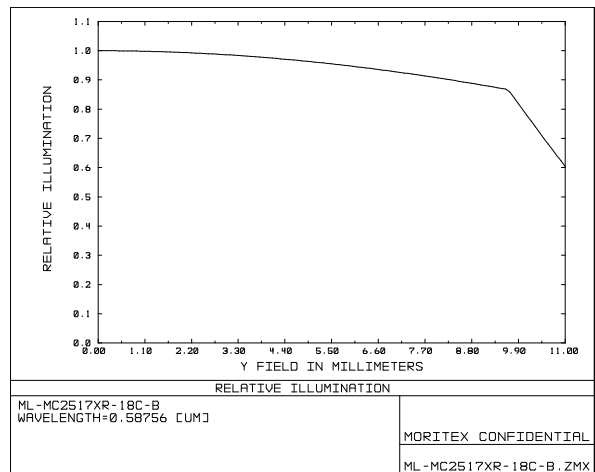
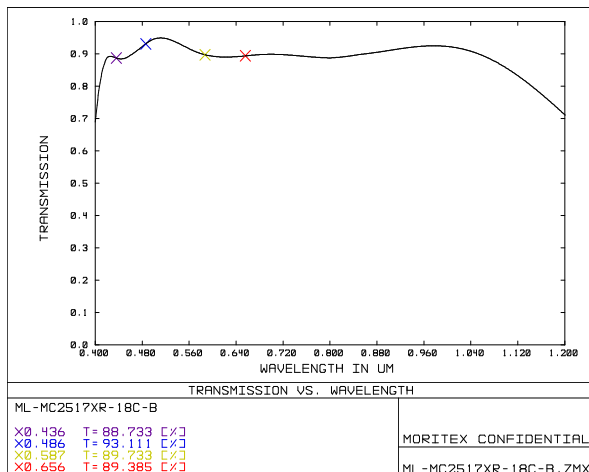
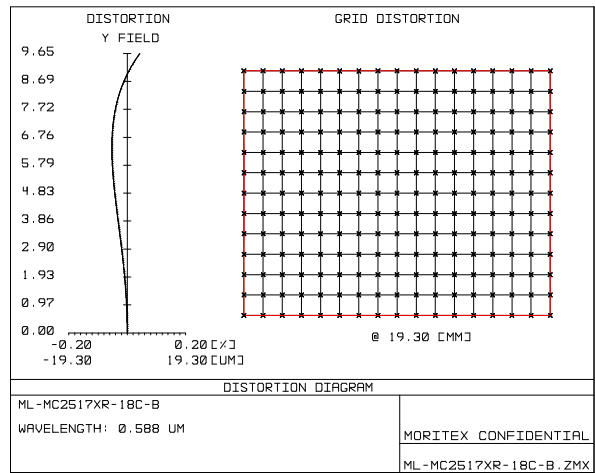
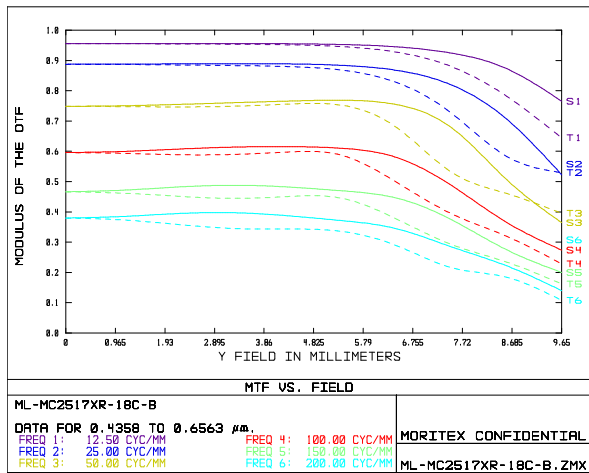

内容は、通知なしに随時変更されることがあります。

The content is subject to change at any time without notification.

株式会社 **モリテックス MORITEX Corporation**

Technology center Lens design & Development technology

moritex.mvs@moritex.com

www.moritex.com



0.32x Fno2.8

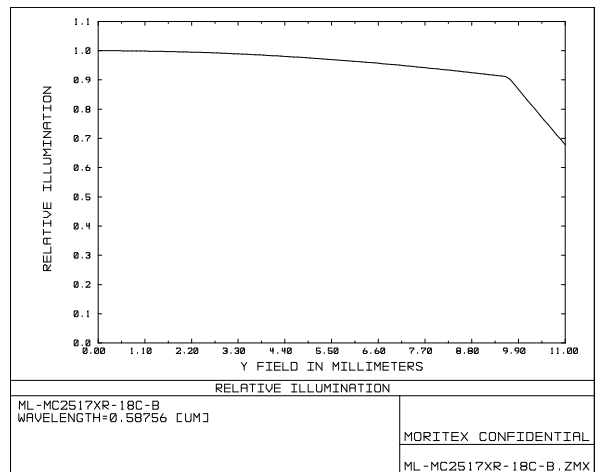
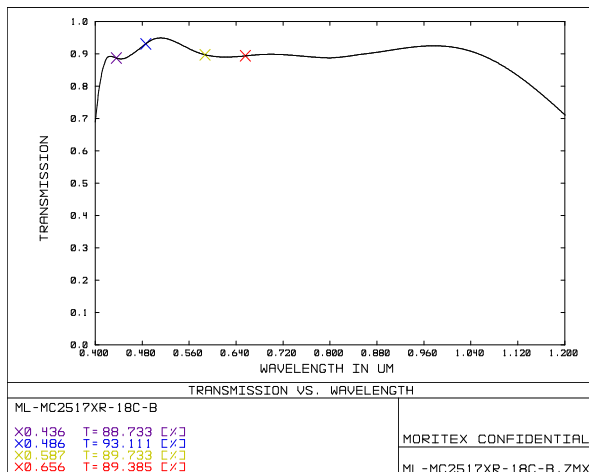
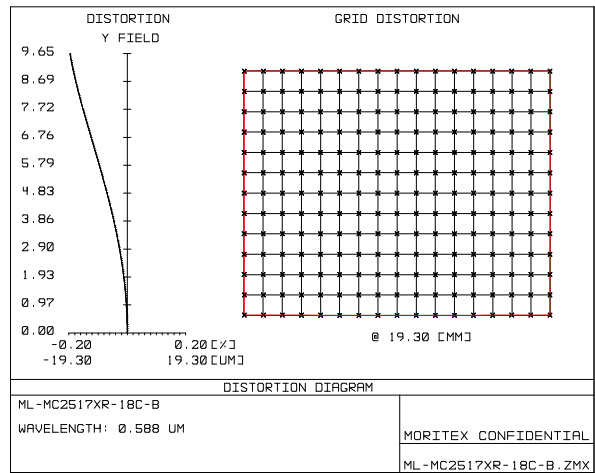
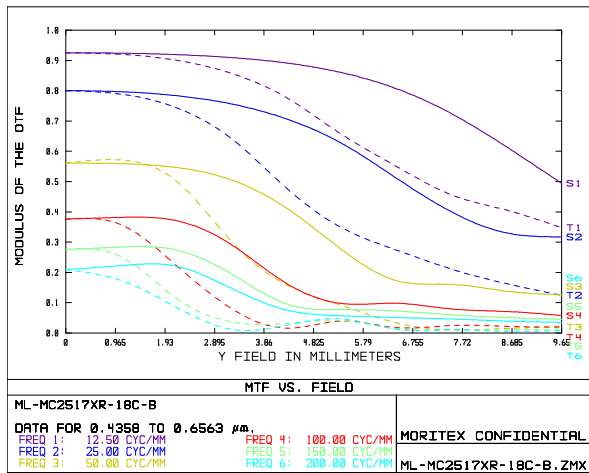

内容は、通知なしに随時変更されることがあります。
 The content is subject to change at any time without notification.

株式会社 **モリテックス MORITEX Corporation**

Technology center Lens design & Development technology
 moritex.mvs@moritex.com
 www.moritex.com

