

ML-MC35UR-16C

ML-MCUR series



Drawing No. A24607

レンズ形式	Lens Type	Macro Lens
光学倍率	Magnification	0.06~0.28
焦点距離 (mm)	Focal Length	34.15~39.01
Fno	Fno	2.50~16.00
NA	Numerical Aperture	-
WD/OD (mm)	Working/Object Distance	550.0~134.3 / 572.6~156.9
O/I (mm)	Object to Image Distance	613.46~208.78
鏡筒長 (mm)	Mechanical Tube Length	45.90~56.90
レンズバック (mm)	Lens Back	12.94
被写界深度 (mm)	DOF @PCoC ϕ 0.04mm	57.529~3.726
分解能 (μ m)	Resolution @ λ =550nm	-
前側/後側主点位置 (mm)	Front/Rear Principal Position	14.93~22.48 / -23.27~-36.89
入射/出射瞳位置 (mm)	Entrance/Exit Pupil Position	16.72 / -21.57~-43.66
入射/出射瞳径 (mm)	Entrance/Exit Pupil Diameter	13.66 / 12.98~16.03
画角(deg.) H×V	Angle Of View @WD=550	$\leq 11.41 \times 8.57(1/1.8 \text{ Inch}) \leq 13.92 \times 10.46(2/3 \text{ Inch}) \leq 20.56 \times 15.55(1 \text{ Inch})$
TVディストーション (%)	TV Distortion @WD=550	$\leq 0.033(1/1.8\text{Inch}) \leq 0.047(2/3 \text{ Inch}) \leq 0.095(1 \text{ Inch})$
周辺光量比 (%)	Relative Illumination @WD=550	$\geq 87.64(1/1.8\text{Inch}) \geq 84.00(2/3 \text{ Inch}) \geq 50.71(1 \text{ Inch})$
質量 (g)	Weight	71.7
マウント	Mount	C Mount
イメージサークル径 (mm)	Image Circle	ϕ 16.4
最大適合カメラ	Largest Compatible Camera	1 Inch

ML-MC35UR-16C

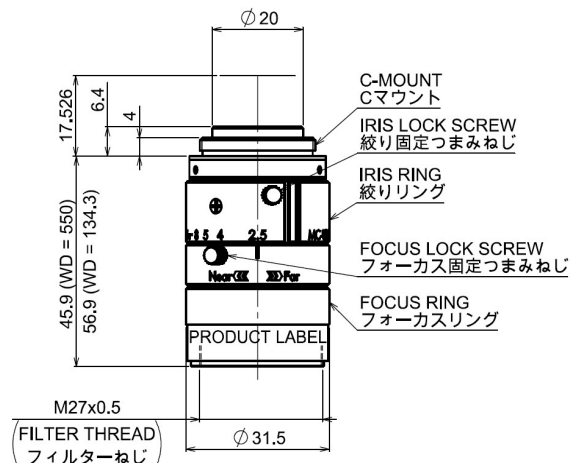

0.06x Fno2.5

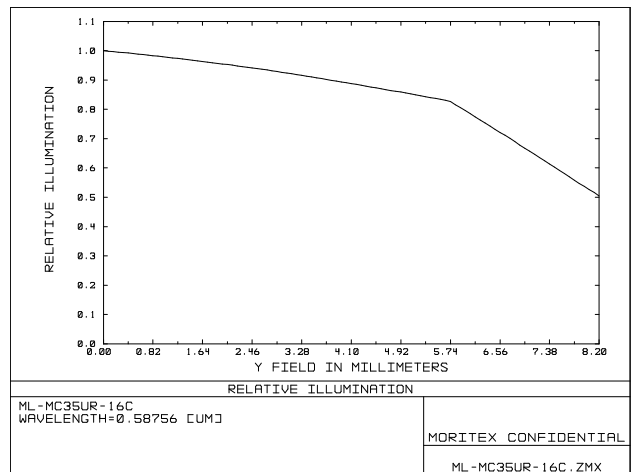
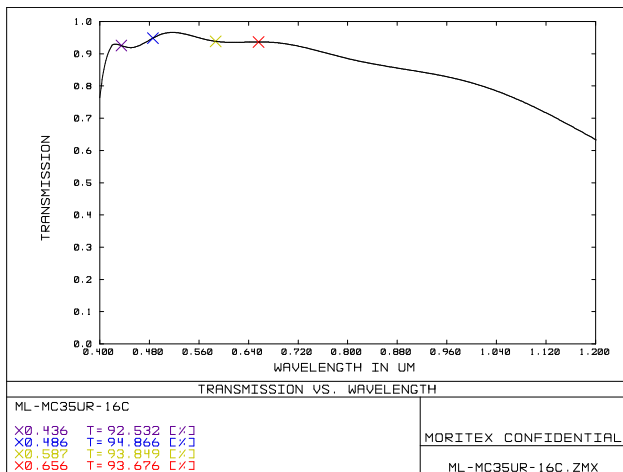
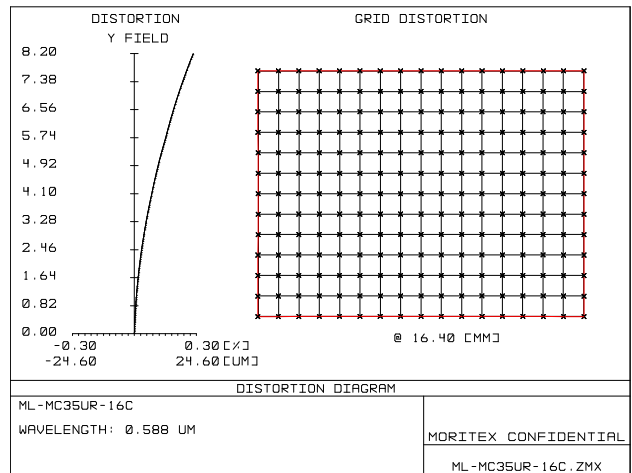
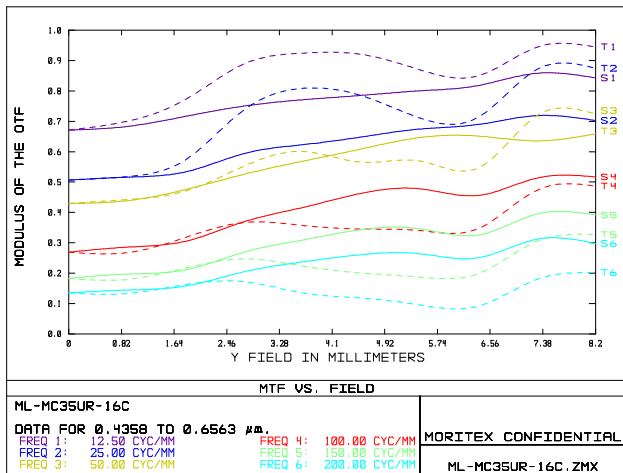

内容は、通知なしに随時変更されることがあります。
 The content is subject to change at any time without notification.

株式会社 **モリテックス** MORITEX Corporation

Technology center Lens design & Development technology
 TEL +81 (0)45-913-5800 moritex.mvs@moritex.com
 www.moritex.com



0.10x Fno2.5

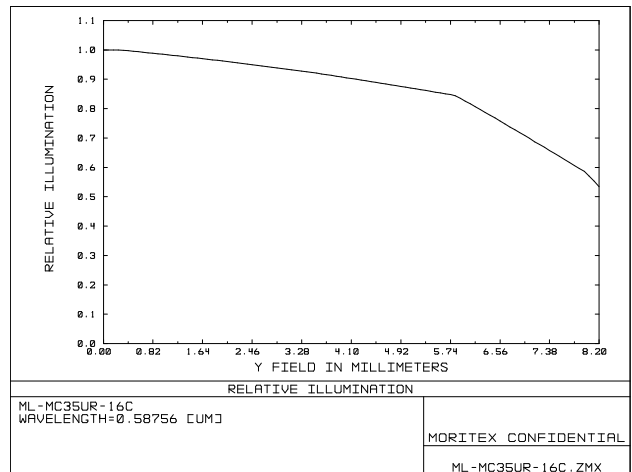
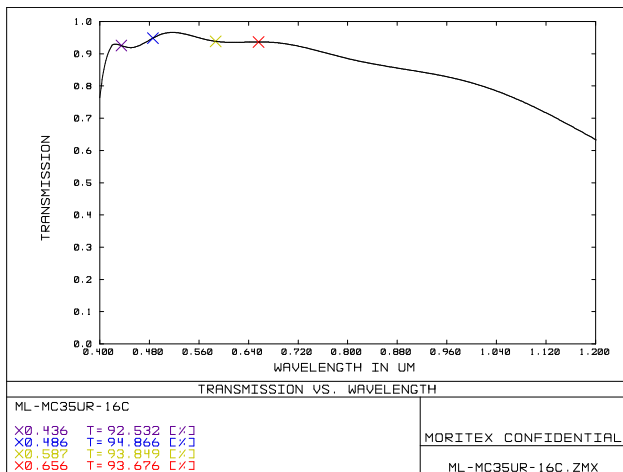
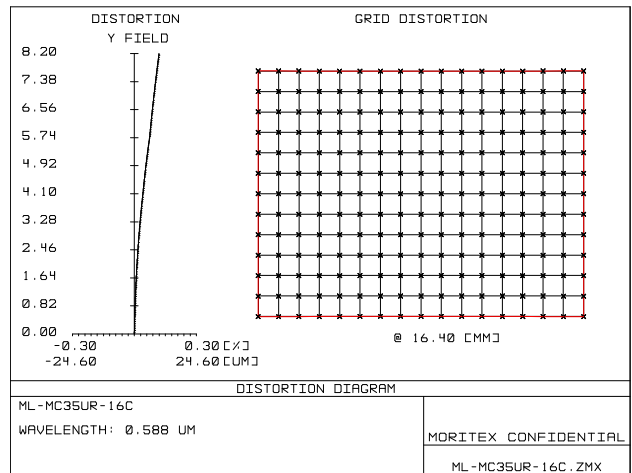
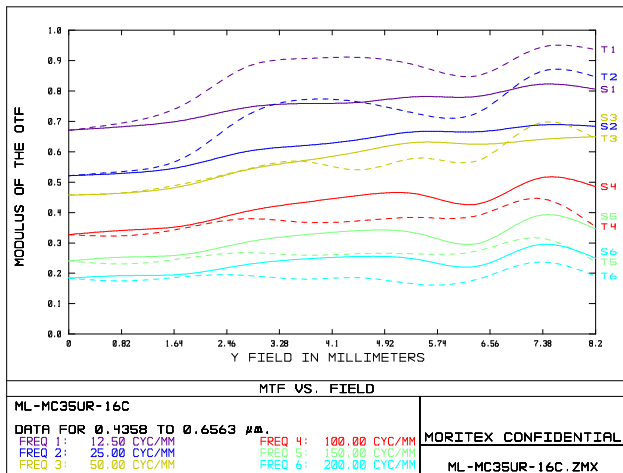

内容は、通知なしに随時変更されることがあります。

The content is subject to change at any time without notification.

株式会社 **モリテックス** MORITEX Corporation

Technology center Lens design & Development technology

TEL +81 (0)45-913-5800 moritex.mvs@moritex.com

www.moritex.com



0.28x Fno2.5

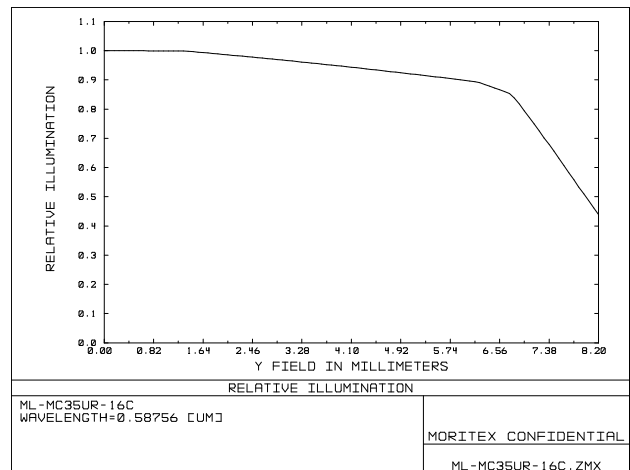
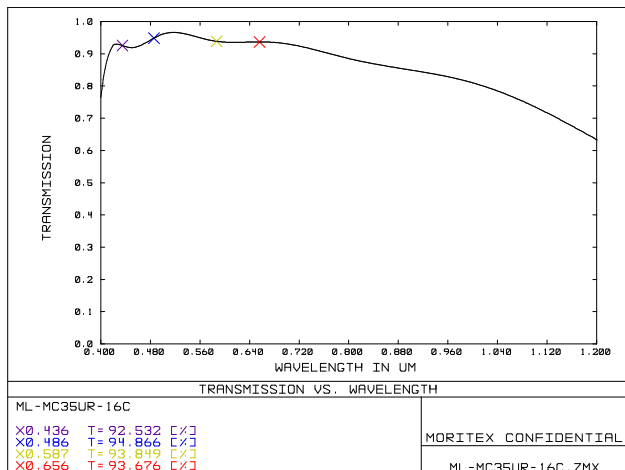
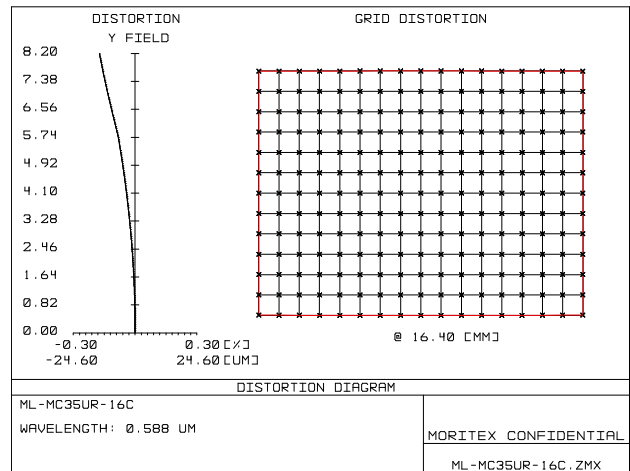
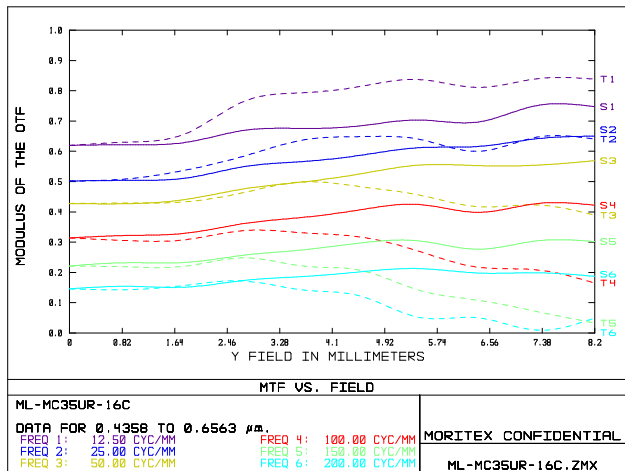

内容は、通知なしに随時変更されることがあります。

The content is subject to change at any time without notification.

株式会社 **モリテックス MORITEX Corporation**

Technology center Lens design & Development technology

TEL +81 (0)45-913-5800 moritex.mvs@moritex.com

www.moritex.com



0.10x Fno4.0

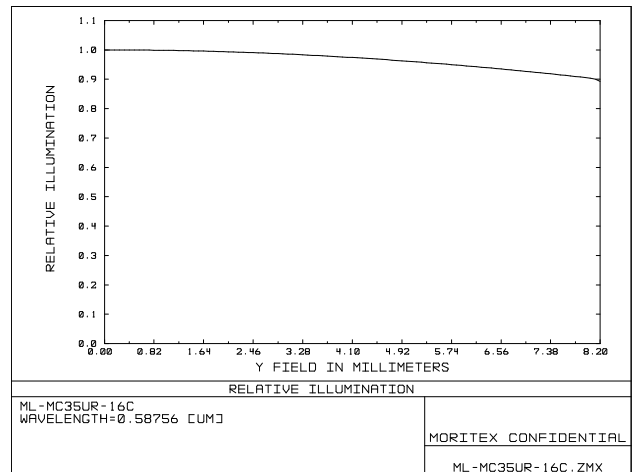
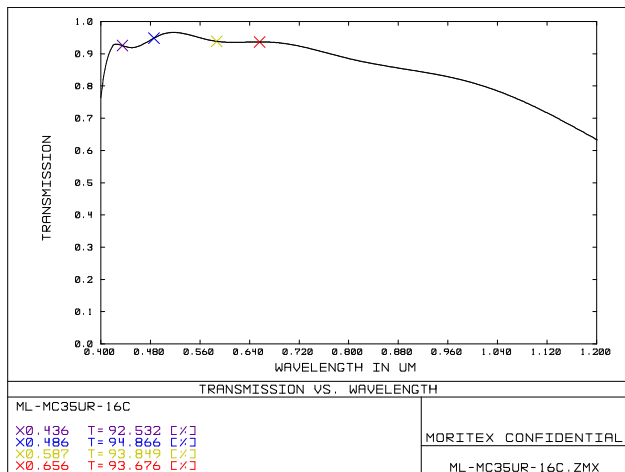
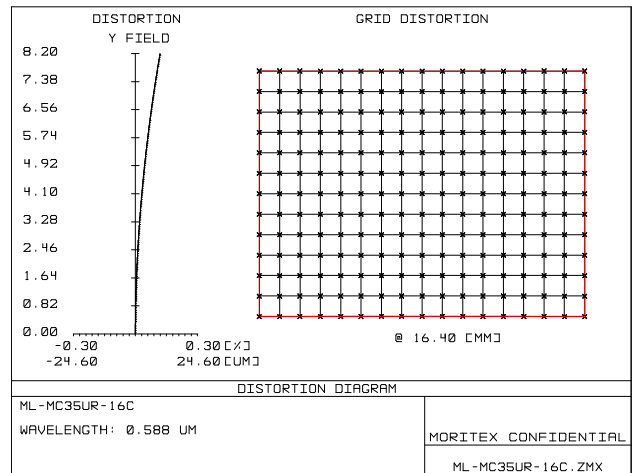
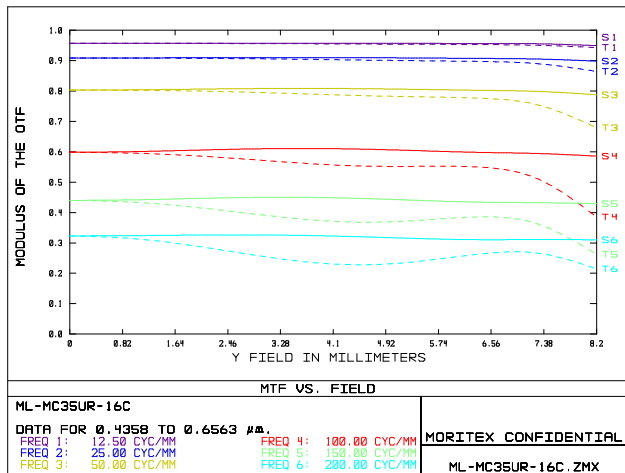

内容は、通知なしに随時変更されることがあります。

The content is subject to change at any time without notification.

株式会社 **モリテックス** MORITEX Corporation

Technology center Lens design & Development technology

TEL +81 (0)45-913-5800 moritex.mvs@moritex.com

www.moritex.com

