

ML-MC25UR-16C

ML-MCUR series



Drawing No. A24597

レンズ形式	Lens Type	Macro Lens
光学倍率	Magnification	0.04~0.12
焦点距離 (mm)	Focal Length	25.00
Fno	Fno	2.50~16.00
NA	Numerical Aperture	-
WD/OD (mm)	Working/Object Distance	700.0~200.0 / 714.2~214.2
O/I (mm)	Object to Image Distance	751.77~253.88
鏡筒長 (mm)	Mechanical Tube Length	34.20~36.40
レンズバック (mm)	Lens Back	12.47~14.58
被写界深度 (mm)	DOF @PCoC ϕ 0.04mm	167.304~15.563
分解能 (μ m)	Resolution @ λ =550nm	-
前側/後側主点位置 (mm)	Front/Rear Principal Position	19.93 / -13.38
入射/出射瞳位置 (mm)	Entrance/Exit Pupil Position	15.91 / -18.18
入射/出射瞳径 (mm)	Entrance/Exit Pupil Diameter	10.03 / 11.96
画角(deg.) H×V	Angle Of View @WD=700	$\leq 15.92 \times 11.98$ (1/1.8 Inch) $\leq 19.41 \times 14.61$ (2/3 Inch) $\leq 28.57 \times 21.67$ (1 Inch)
TVディストーション (%)	TV Distortion @WD=700	≤ 0.025 (1/1.8 Inch) ≤ 0.036 (2/3 Inch) ≤ 0.079 (1 Inch)
周辺光量比 (%)	Relative Illumination @WD=700	≥ 92.63 (1/1.8 Inch) ≥ 81.55 (2/3 Inch) ≥ 34.56 (1 Inch)
質量 (g)	Weight	55.2
マウント	Mount	C Mount
イメージサークル径 (mm)	Image Circle	ϕ 16.4
最大適合カメラ	Largest Compatible Camera	1 Inch

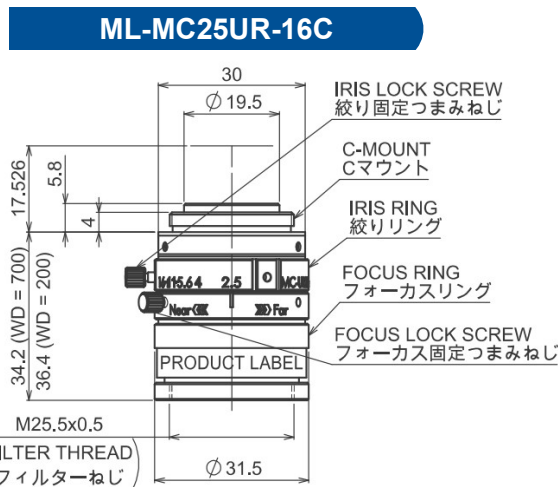

0.04x Fno2.5

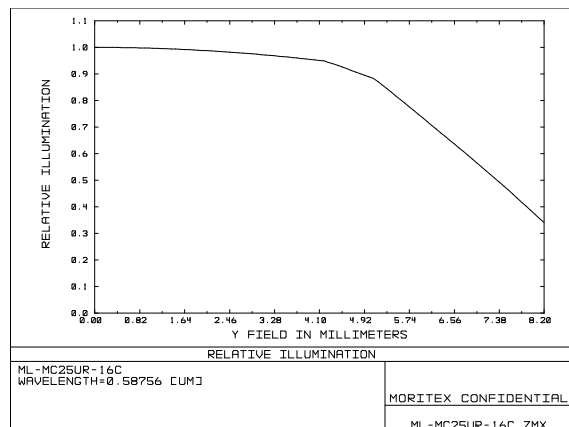
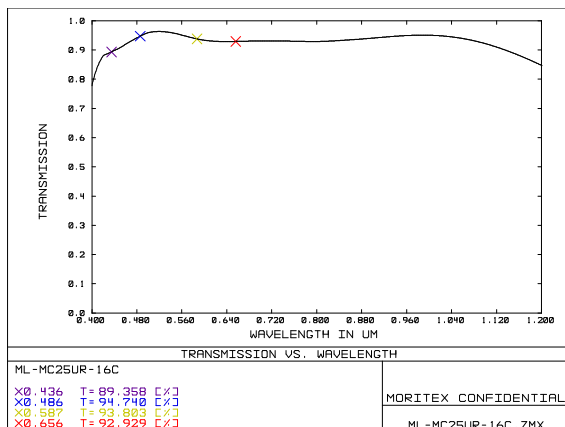
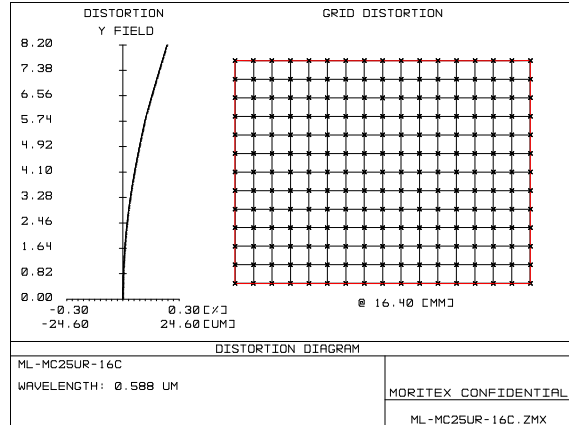
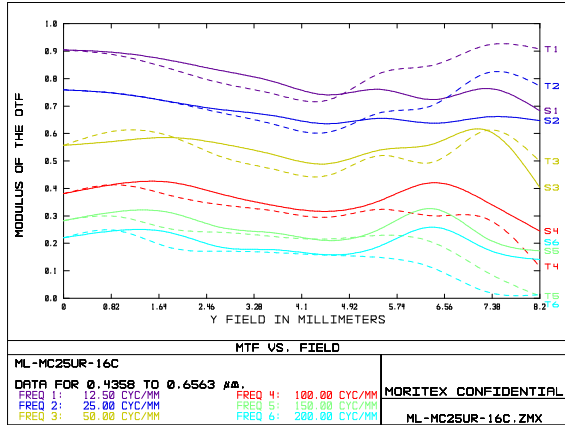

内容は、通知なしに随時変更されることがあります。
 The content is subject to change at any time without notification.

株式会社 **モリテックス** MORITEX Corporation

Technology center Lens design & Development technology
 TEL +81 (0)45-913-5800 moritex.mvs@moritex.com
 www.moritex.com



0.07x Fno2.5

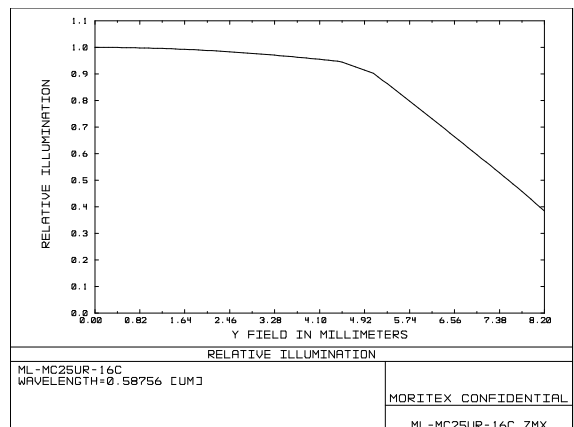
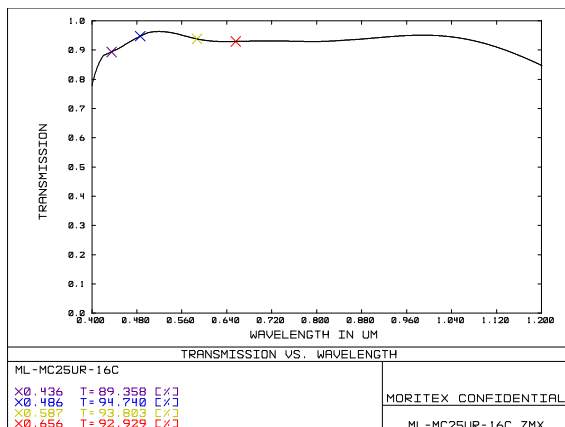
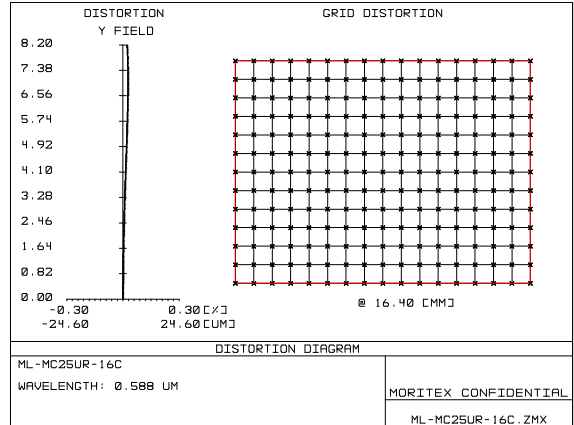
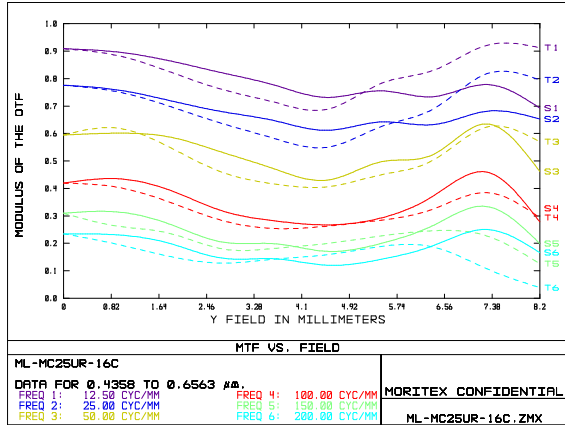

内容は、通知なしに随時変更されることがあります。
 The content is subject to change at any time without notification.

株式会社 **モリテックス** MORITEX Corporation

Technology center Lens design & Development technology
 TEL +81 (0)45-913-5800 moritex.mvs@moritex.com
 www.moritex.com



0.12x Fno2.5

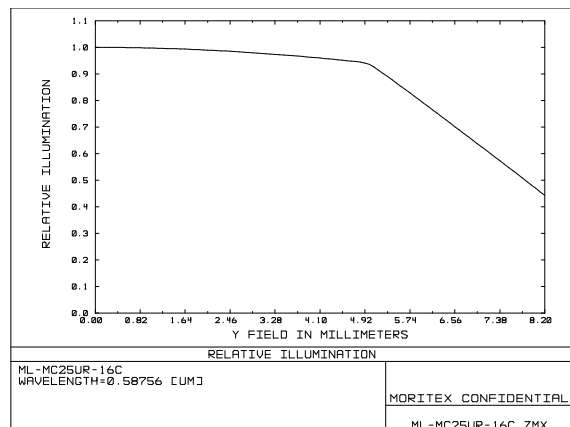
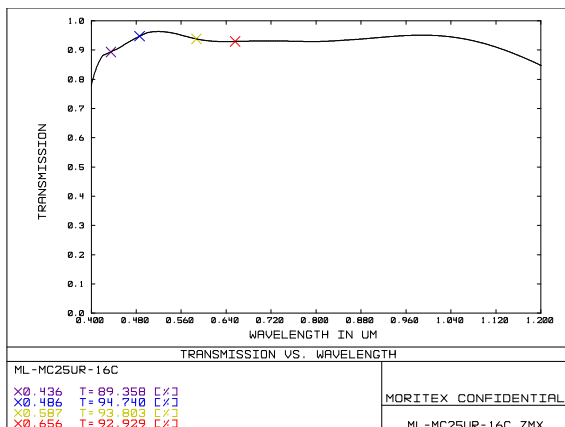
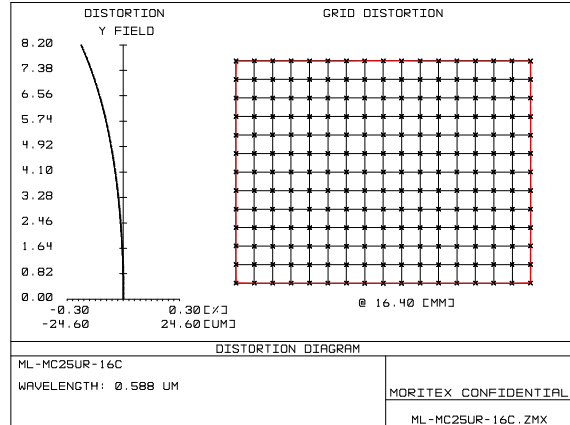
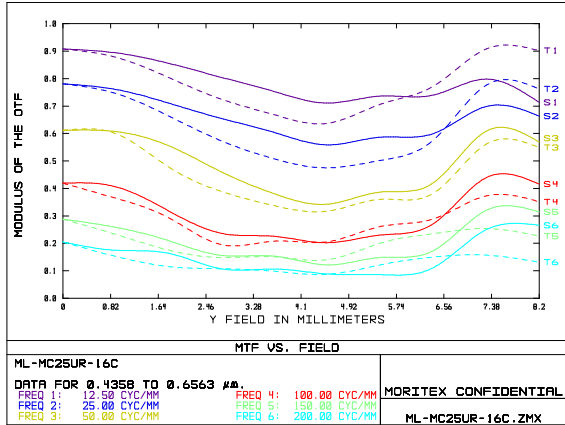

内容は、通知なしに随時変更されることがあります。
The content is subject to change at any time without notification.

株式会社 モリテックス MORITEX Corporation

Technology center Lens design & Development technology
TEL +81 (0)45-913-5800 moritex.mvs@moritex.com
www.moritex.com



0.07x Fno4.0

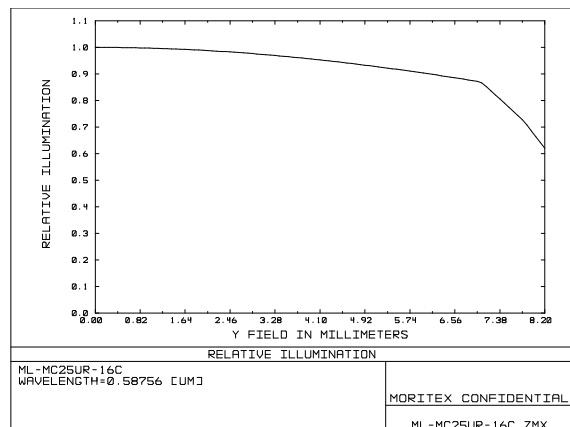
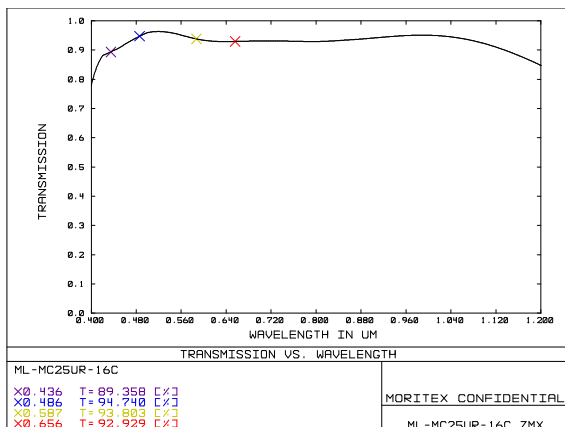
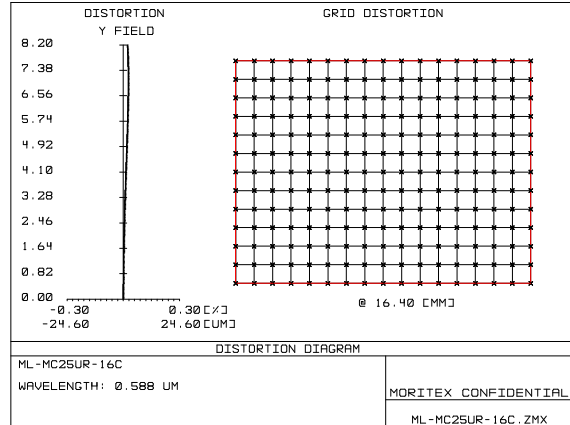
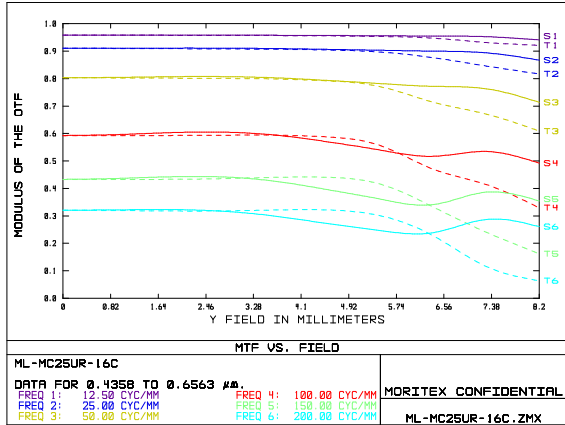

内容は、通知なしに随時変更されることがあります。
The content is subject to change at any time without notification.

株式会社 モリテックス MORITEX Corporation

Technology center Lens design & Development technology
TEL +81 (0)45-913-5800 moritex.mvs@moritex.com
www.moritex.com

