

ML-M5025HR

ML-M-HR series

Drawing No. A23248



		Lens Type	CCTV Lens	
		Focus Position	Reference Magnification	M.O.D
		Magnification	0.109	0.195
	(mm)	Focal Length	50.00	50.00
Fno		Fno	2.50 16.00	
NA		Numerical Aperture	-	-
WD/OD (mm)		Working/Object Distance	500.0 / 511.0	300.0 / 311.0
O/I (mm)		Object to Image Distance	564.56	368.77
	(mm)	Mechanical Tube Length	41.60 51.70	
	(mm)	Lens Back	25.05	29.26
	(mm)	DOF @PCoC 0.04mm	20.223	7.087
	(μ m)	Resolution @ $\lambda=550$ nm	-	-
/	(mm)	Front/Rear Principal Position	-3.92 / -30.39	-3.92 / -30.39
/	(mm)	Entrance/Exit Pupil Position	20.04 / -14.19	20.04 / -14.19
/	(mm)	Entrance/Exit Pupil Diameter	20.09 / 13.58	20.09 / 13.58
	(deg.)	H x V Angle Of View	8.79 x 6.50	7.99 x 5.94
TV	(%)	TV Distortion	0.066	0.034
	(%)	Relative Illumination	85.69	88.83
	(g)	Weight	60	
		Mount	C mount	
	(mm)	Image Circle	11	
		Largest Compatible Camera	2/3 Inch	

ML-M5025HR

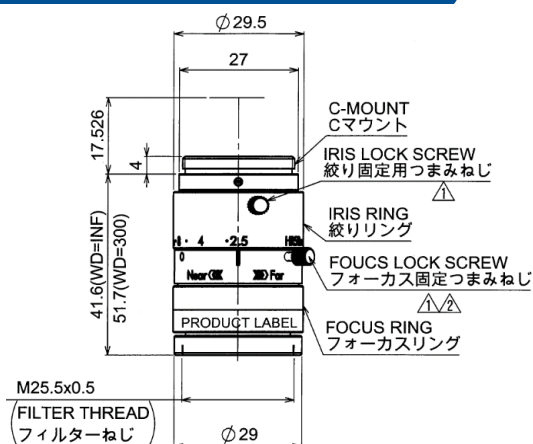

WD=500.0mm Fno2.8

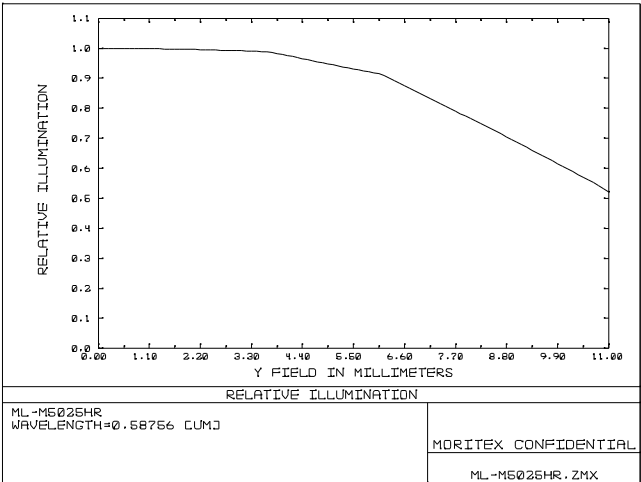
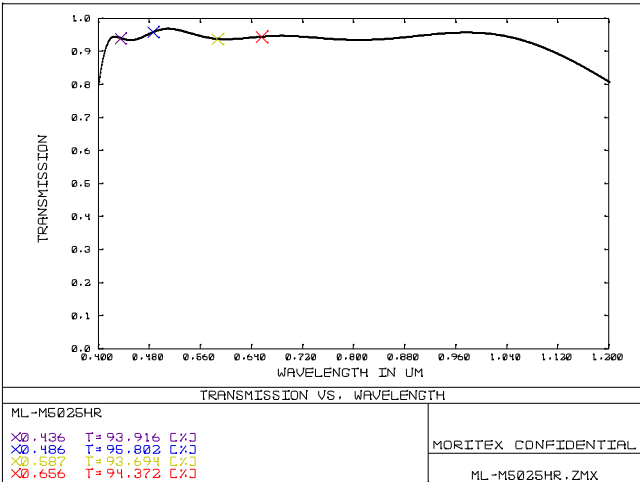
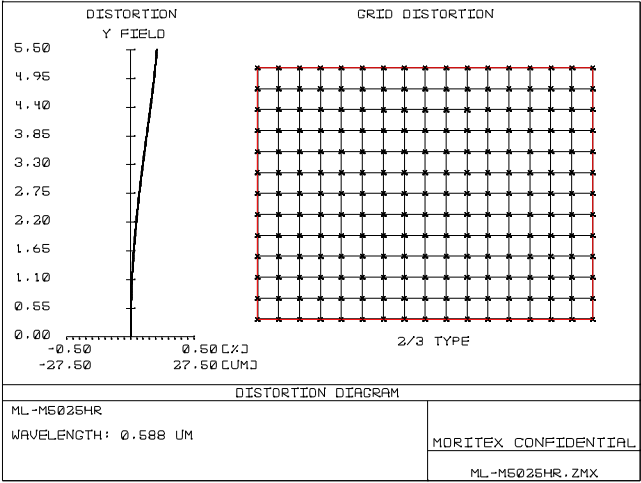
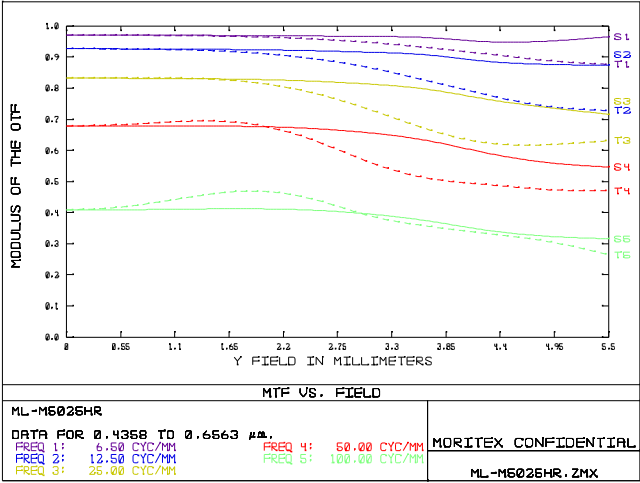

The content is subject to change at any time without notification.

株式会社 **モリテックス** **MORITEX Corporation**

Technology center Lens design & Development technology
 TEL +81 (0)48-218-2536 moritex.mvs@moritex.com
 FAX +81 (0)48-462-6713 www.moritex.com



WD=300.0mm Fno2.8

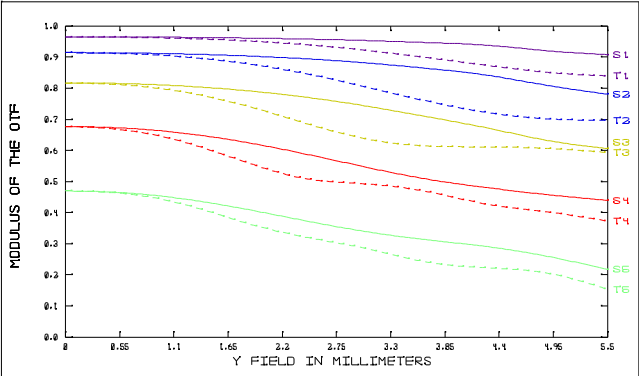

ML-M5025HR		MORITEX CONFIDENTIAL	
DATA FOR 0.4368 TO 0.6563 μm			
FREQ 1:	6.50 CYC/MM	FREQ 4:	50.00 CYC/MM
FREQ 2:	12.50 CYC/MM	FREQ 5:	100.00 CYC/MM
FREQ 3:	25.00 CYC/MM		
		ML-M5025HR.ZMX	

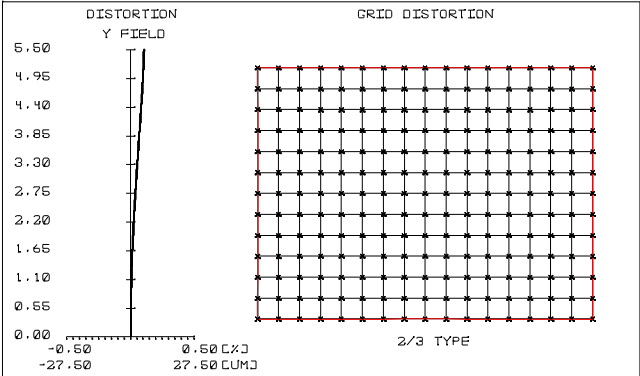

ML-M5025HR		MORITEX CONFIDENTIAL	
WAVELENGTH: 0.588 μm			
		ML-M5025HR.ZMX	

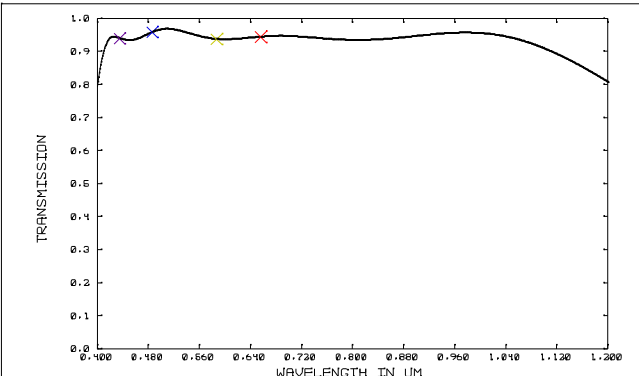

ML-M5025HR		MORITEX CONFIDENTIAL	
X0.436	T=93.916 C%J		
X0.486	T=95.802 C%J		
X0.587	T=93.694 C%J		
X0.656	T=94.372 C%J		
		ML-M5025HR.ZMX	

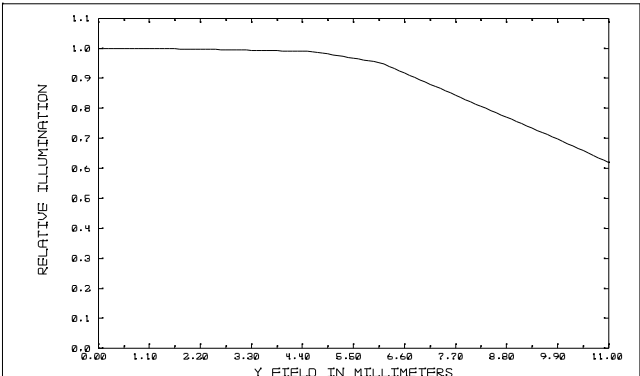

ML-M5025HR		MORITEX CONFIDENTIAL	
WAVELENGTH=0.58756 μm			
		ML-M5025HR.ZMX	

The content is subject to change at any time without notification.

株式会社 モリテックス MORITEX Corporation

Technology center Lens design & Development technology
 TEL +81 (0)48-218-2536 moritex.mvs@moritex.com
 FAX +81 (0)48-462-6713 www.moritex.com

