

LED Controller for MG-Wave

MLEK-A080W2LR

MLEK-A230W2LR

INSTRUCTION MANUAL

- Table of Contents -

Table of Contents	13	4. Connections	17
1. Introduction	13	External Signal Connector	17
Precautions for Correct Use	14	Connector for Illuminator	19
Warranty	14	5. Maintenance	19
Confirming Package Contents	15	Troubleshooting	19
2. Features	15	6. Specifications	20
3. Installation	16	Optional Items	21
Basic System Configuration	16	Dimensions	22
Equipment Control	16	7. Others	23
Installation	17	《Appendix》	24

1. Introduction

Please read this instruction manual carefully, before starting operation. Keep this book for the whole product lifetime, and store it in a place easily accessible.

Meanings of Warning Symbol		The following warning symbol is used in this manual. Be sure to fully understand the contents of the warning.
	WARNING	This warning marking indicates a potentially hazardous situation, which can result in hazard to the operator or damage to the unit, if the directions of this Instruction Manual are not followed.

Precautions for Correct Use



WARNING

Use this product only after understanding contents of the following:

- If using this product in combination with other apparatuses, please confirm the correctness/compatibility of the connection with these external apparatuses (especially regarding insulation requirements).
- If using this product in combination with other apparatuses, please confirm any standards, codes, or regulations that apply to the combination of the apparatuses.
- If using this product in combination with other apparatuses, please confirm that installation, connection and use within the entire system is according to the specification of this product (as described in this Instruction Manual) and according to those of all other apparatuses.
- Never use the product for an application involving serious risks to life or property as long as the whole system is not equipped with appropriate safety measures of the relevant safety category.
- Please install this product in such a way that water cannot sprinkle into it.
- Whenever some matter/dirt stuck to the product, please completely wipe it off, using a dry cloth.
- This product needs periodical inspection and exchange of maintenance parts.
- Whenever trouble occurs, please request repair to MORITEX, and do not dismantle the product by your own.

Other precautions

- When a customer wants to scrap the product, the whole equipment has to be disposed as industrial waste, according to laws and ordinances of the customer's area.
- Dimensions and Weights are reference.
- Specifications of the product (or accessories or optional items) may be changed at any time based on improvements and other reasons without any notice.
- Please inquire to MORITEX about indistinct contents.

Warranty

The term of a warranty

The warranty of this product lasts for two years from the date of purchase. In case of product failure within two years from the date of purchase, and there is no doubt on the correct utilization of the product, according to this instruction manual the unit will be repaired at no charge.

Limitations of warranty

When inconvenience due to our responsibility occurs to a product during the warranty period, the part that has trouble will be changed to a new part, or repaired, free of charge. But, if the cause of the trouble fits to the following, the product is out of warranty.

- The cause of the trouble is of such technical nature that could not be foreseen at the time of shipment.
- The trouble is not caused by this product.
- The trouble is caused by modification or repair by a person other than MORITEX.
- The trouble is caused by unauthorized use, not conforming to this Instruction Manual.
- The trouble is caused by the inappropriate handling such as a drop or a shock.
- The trouble is repaired by MORITEX at on-site service.
- The trouble is caused by a condition out of our responsibility such as a natural disaster or pollution.
- The cause of the trouble cannot be identified by MORITEX.

MORITEX shall not be responsible for indirect or consequential damages, in any way related to this product. The responsibility of MORITEX for any act shall not exceed the price of this product. The warranty is limited to business and use in Japan. Please inquire to MORITEX about warranty overseas.

Confirming Package Contents

Part name	Quantity	Unit	Notes
Main body	1	piece	—
Power Supply Cord Set	1	piece	※1,2
Instruction Manual	1	book	This book

※1 『MC-AC100A-2.0M』 is attached to 『-100V』 model. 『MC-AC200A-2.0M』 is attached to 『-200V』 model. (It depends on the suffix of the model that was purchased.)

Before connection to the power supply, please check the conformity of the specifications of the Power Supply Cord Set with the laws and standards of your country as well as the correct power and temperature rating.

Refer to Page 17: Installation, Page 20: Specifications, Page 21: Optional Items

※2 An attached AC cord set is an AC cord set for exclusive use of this product. Other than this product, please do not use it.

2. Features

Applicable Illuminators

Requirements for applicable MG-Wave Illuminators (made by MORITEX) ※1,2

MLEK-A080W2LR: Illuminator of up to 0.8 [A] /4pin

MLEK-A230W2LR: Illuminator of up to 2.3 [A] /4pin or 4pin+2pin

Output

Number of output channels: 2 channels

※ Each output channel is controlled separately.

Manual illuminance adjustment function

It is possible to adjust the illuminance of the Illuminator by using the Output Control SW on the front-panel.

※ It is possible to control each channel separately.

※ Manual adjustment of the illuminance is possible when selecting MANU mode (MANU/REMO SW)

※ Hexadecimal control: 0,1,····,E,F

※ (COARSE, FINE): (0,0) = MIN; (F,F) = MAX

※ Range between (0,0) and about (0,5) does not turn on the Illuminator.

Remote illuminance adjustment function

It is possible to adjust the illuminance of the Illuminator by inputting an EXT_0-5V analog voltage or EXT_VR signal (0-2.5V / at using 2.5Vref) to the External Signal Connector on the rear-panel.

※ It is possible to control each channel separately.

※ Remote adjustment of the illuminance is possible when selecting REMO mode (MANU/REMO SW)

※ Input 0V: MIN, Input 5V or 2.5V (2.5Vref): MAX

※ It is possible to change EXT_0-5V or EXT_VR by inputting a signal to the External Signal Connector.

Output ON/OFF function

It is possible to turn off the Illuminator by inputting a relevant signal to the External Signal Connector.

※ It is possible to control each channel separately.

※ Operation of this function is possible regardless of the MANU/REMO setting.

Sensor error signal output function

When illuminator is not connected, the unit shuts down the output power to the Illuminator and puts out a Sensor error signal at the External Signal Connector.

※ Error signal is output at each channel separately.

※ This function works independent of the MANU/REMO setting.



WARNING

※1 Do not connect anything to output except designed Illuminator.

※2 Please never exceed specified current values.

3. Installation

Basic System Configuration

- This Unit is dedicated for use with/for connection to the MG-Wave Illuminator.
- For external control, it is possible to connect an external apparatus via the External Signal Connector.

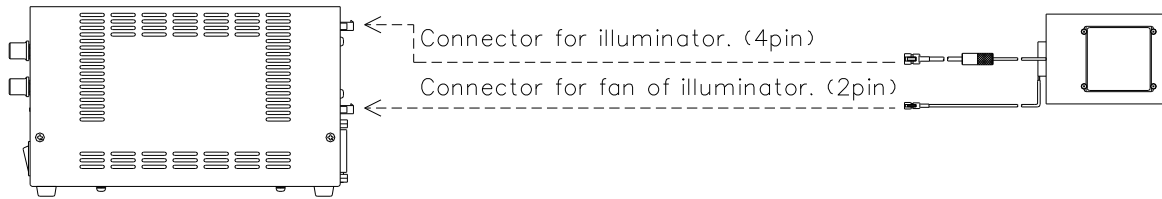

- ※ MLEK-A230W2LR unit has an additional connector for the fan of the Illuminator. Please do not use it for any uses other than this.
- ※ The cables for connection to the EXT Connector and to the Illuminator and to the Fan of the Illuminator are supplied as Optional Item (MC-EXC-02, M-RCB4**L, M-RCB0**L).

Equipment Control

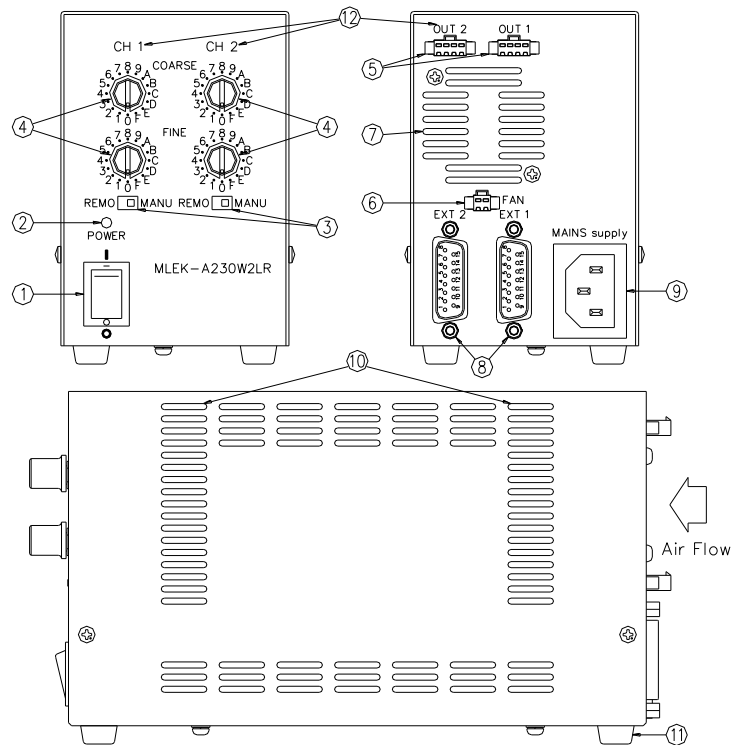

①	Power SW	Tilt to "I" side for turning on power.
②	Power Indicator	LED illuminates when power supply is ON.
③	MANU/REMO SW	Switch for selecting manual or remote control.
④	Output Control SW	Manual adjustment switch for output-control.
⑤	Connector for Illuminator: OUT1/2	Terminal for connection to the Illuminator.
⑥	Connector for Fan of Illuminator: FAN	Terminal for connection to the fan of the Illuminator.
⑦	Cooling-Fan	Air inhaling type fan for cooling unit interior.
⑧	External Signal Connector: EXT1/2	Terminal for external control.
⑨	MAINS supply	Inlet for connecting power supply cable.
⑩	Air Hole	Air hole for cooling forced by Fan (air-exhalation).
⑪	Rubber Feet	Take them off, when using with the optional installation bracket.
⑫	Indication of Channels	Indicates channel number for terminals below.

※ Drawings show the MLEK-A230W2LR unit.

※ MLEK-A080W2LR does not have ⑥,⑦.

Installation

Install horizontally on the rubber feet at the bottom of the unit.

- ※ Install the unit in such a way, that adequate space is left free for ventilation. Keep space of at least 10mm around the main body.
- ※ Be sure to install the unit in such a way that the Power Switch can be operated easily and the Mains Plug can be pulled out without hindrance, in case of emergency.
- ※ Protection Class: Class I equipment.
- ※ Before using this product, please provide an appropriate power supply cord set conforming to the input power ratings and to the relevant standards of the area where you use this product.
- ※ The power supply cord set shall have following configurations:
Length: < 3 m; Conductors: L / N / PE; Class I type mains plug with reliable connection to the Protective Earthing Conductor of the Building Installation.
Optional Item MC-AC200A-2.0M does comply with these requirements.

4. Connections

	WARNING	<ul style="list-style-type: none"> • Only SELV circuits, which have reinforced insulation to their equipment primary circuit, may be connected to the unit. • For connection to the External Signal Connector, use a shielded cable with a recommended length of less than 2 m (Optional item: MC-EXC-02) • Please do not excessive input or overload.
---	----------------	---

External signal connector (EXT)

Model

Terminal of the Unit	Connector for the cable
HDAB-15P(05)(male) (made by HRS) Screws : M2.6	HDAB-15S(05) : connector(female) (made by HRS) HAD-CTH : connector (made by HRS) or its equivalent

Pin assignment

No	Identification	No	Identification
1	Input ON/OFF signal + ※1	9	EXT_VR (Volume control signal) ※4
2	Input ON/OFF signal - ※1	10	EXT_0-5V (Analog control signal) ※5
3	NC	11	EXT_GND
4	NC	12	EXT_0-5V / EXT_VR Selection input ※3
5	Sensor error signal output (OC) ※2	13	DC2.5V Reference Voltage output ※4
6	Sensor error signal output (OE) ※2	14	NC
7	NC	15	NC
8	NC		

※1 It is possible to input a voltage between 5V and 24V.

Input a voltage between 5V and 24V Output OFF

Input 0V or Input open Output ON

• Please do not change the input voltage during operation.

• Operation possible regardless from MANU/REMO selection.

• Input Current : 1mA (Input 5V), 6mA (Input 24V)

※2 Normal Condition (no error detected) : Open Circuit, Sensor Error detected : Short circuit

• Please use signal with current equal or less than 4mA and DC24V.

• Function regardless of MANU/REMO selection.

※3 Open-Collector type input or DC5V input are possible.

Input DC5V or Input open EXT_0-5V

Short GND EXT_VR

• Only for REMO Control

• Output current is 0.5mA at short to GND. (Pull up to DC5V with 10KΩ resistor.)

※4 Input to EXT_VR(9) conforms to only a signal of variable resistor of 10KΩ connected to 2.5 Vref(13P) and GND(11P).

• Input 0V (GND) : Min / Input 2.5V : Max

• Please do not use 2.5 Vref besides a designated usage.

※5 Circuited to GND with 10KΩ resistor.

• Input 0V(GND) : Min / Input 5V : Max

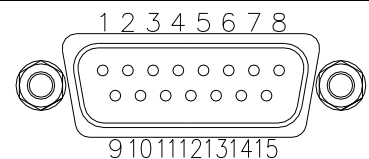

Example of input and output circuit

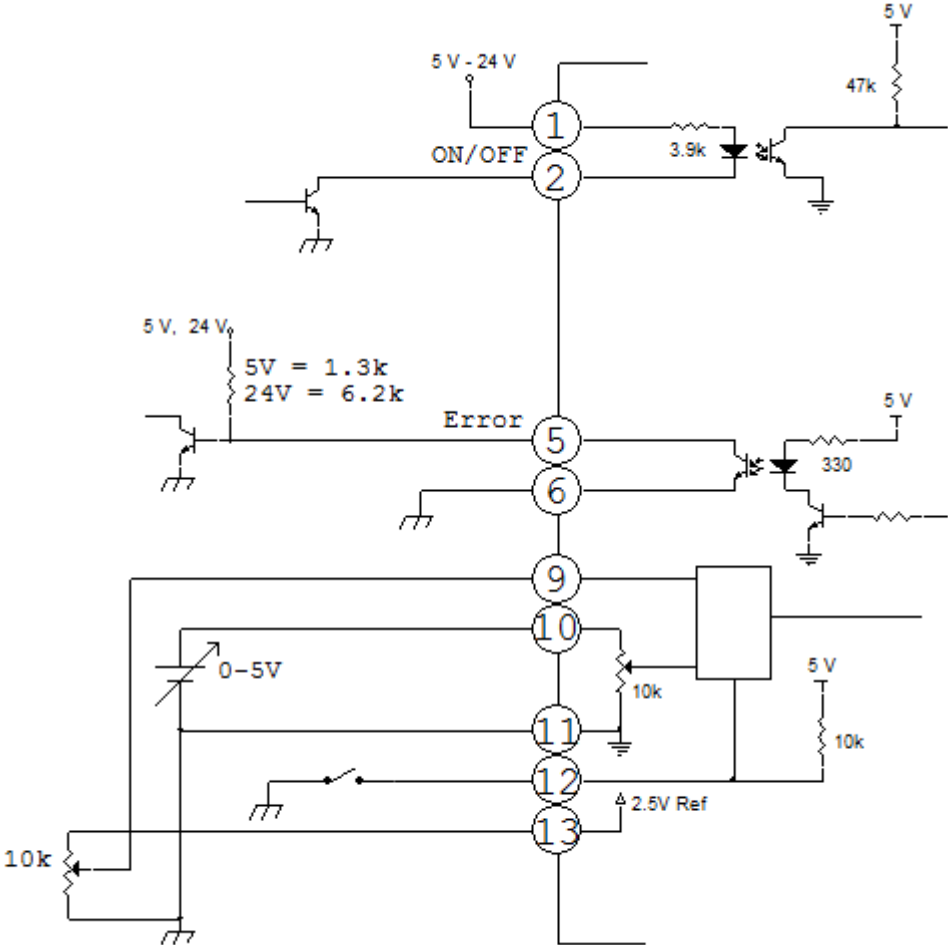

Connector for Illuminator (for MG-Wave Illuminator, Identical specification for each channel)

Model

Output Connector of the Unit	Connector of the Illuminator	
SMP-04V-BC (made by JST)	SMR-04V-B (made by JST) or its equivalent	※1
SMP-02V-BC (made by JST)	SMR-02V-B (made by JST) or its equivalent	※2,3

※1 Connector for illuminator.

※2 Connector for fan of illuminator. Please do not use this terminal besides a designated usage.
(FAN, only at MLEK-A230W2LR unit.)

※3 FAN of Illuminator does not operate unless Illuminator is connected.

Pin assignment: Connector for Illuminator (OUT1, OUT2)

No	Function / Identification	
1	Output Current (+)	※1
2	Sensor (+)	※2
3	Sensor (-)	※2
4	Output Current (-)	※1

※1 Maximum Output voltage is 12.5V.

※2 The Sensor has been preset for illuminators of the MG-Wave series (4pin type)

Please do not connect anything else than illuminators of the MG-Wave series (4pin type).

Optional item: M-RCB4 * * L

Pin assignment: Connector for Fan of Illuminator (FAN)

No	Function / Identification	
1	Output voltage (+)	※1
2	Output voltage (-)	※1

※1 Maximum Output voltage is 12.5V

Optional item: M-RCB0 * * L

5. Maintenance



WARNING

- Please turn off the power switch and detach all connections before doing maintenance.
- Please never take the product apart.

- Please periodically wipe off any dirt by a dry cloth.
- If the contamination is worse, wipe it off with a cloth that has been lightly immersed in a weak solution of neutral detergent.

Troubleshooting: Before requesting repair, check the following items.

Symptom	Cause	Remedy
Illuminator does not turn on.	- Are all connectors correctly attached? - Is the MANU/REMO correctly set?	- Please attach connectors correctly. - Please set MANU/REMO correctly.
Illuminator remains dark.	- Is the output control correctly adjusted? - Are the external signals correctly set?	- Please adjust output control. - Please connect signals correctly.
Unit does not turn ON/OFF.	- Are the external signals correctly set?	- Please connect signals correctly.
No Output Signal	- Are the external connections correctly set?	- Please correct the set-up.

6. Specifications

Model	MLEK-A080W2LR	MLEK-A230W2LR
Input Voltage	AC100-240 [V] (TN-C power distribution system) ※1	
Input Current	0.3/0.15 [A] (AC100/ 240 [V])	0.7/0.4 [A] (AC100/ 240 [V])
Input Frequency	50/60 [Hz]	
Rushing Current	15 [A]max. at AC100 [V] 35 [A]max. at AC240 [V]	15 [A]max. at AC100 [V] 35 [A]max. at AC240 [V] ※2
Number of Outputs	2 channel (Each channel is controlled separately)	
Output Voltage	Max 12.5 [V]	
Output Current	0.8 [A]max. : Shared (0.8[A]max. : when using 0.8 [A] illuminator)	2.3 [A]max. : Shared (2.3[A]max. : when using 2.3 [A] illuminator)
Output Control	Constant current control	
Output Characteristics	Continuous DC output	
Output Adjustment Function	Yes Manual / Remote (Channels are controlled separately)	
Output Range	0 – 100 [%]	
Remote Control	Yes (Channels are controlled separately) EXT0-5V / EXT VR (with changeover function) Output ON/OFF control	
Signal Output	Yes Sensor Error Signal	
Protection Function	Shut down of an output (when illuminator is not connected)	
Environment Conditions	Indoor use Altitude up to 2000m Temperature 0°C to 45°C Maximum 80%RH for temperatures up to 31°C decreasing linearly to 50%RH at 40°C MAINS supply voltage fluctuations up to ±10% of the nominal voltage Installation category II For use up to Pollution degree 2	
Storage Temperature/Humidity	-20~85 [°C] / 20~85 [%RH] (non-condensing)	
Installation Method	Horizontal installation on rubber feet.	
Protection Class	Class I equipment	
Cooling Method	Air-cooling	Air-cooling forced by FAN
International Protection Degree	IP30 (EN60529) ※3	
Dimensions	W75×H110×D190 (Protuberances excluded)	
Mass	Approximately 1.3 [kg]	Approximately 1.4 [kg]
CE Marking	LVD:2014/35/EU , EMC:2014/30/EU RoHS:2011/65/EU, 2015/863 ※4	

※1 Please use power supply cord set satisfying the input AC voltage / current ratings of the unit and complying to the relevant standards / laws of the area where you use this product. (Please confirm a model of an attached power supply cord set to the product with the table of optional items.)

※2 Specification for cold-start

※3 An object equal to or more than a diameter of 2.5mm does not reach hazardous parts inside the unit. The unit is not protected against invasion of water.

※4 MLEK-A080W1LRD, MLEK-A230W1LRD and all Optional Items, except stated explicitly do comply to these European Standards upon which CE marking is declared. Additionally, please use a Class I power supply cord set which confirms to CE marking in order to conform the unit to CE marking. (Optional Item MC-AC200A-2.0M does comply with CE marking.)

Optional items

Name	Model	CE	O:Yes x:No
Relay cable for Illuminator (optional sales)	M-RCB * * L (Relay cable for 4pin connector) * *:length (01=1m, 02=2m, 03=3m)	※1	1m,2m:○ ※5 3m: x
Relay cable for FAN of Illuminator (optional sales)	M-RCB * * L (Relay cable for 2pin connector) * *:length (01=1m, 02=2m, 03=3m)	※1	1m,2m:○ ※5 3m: x
AC200V Power Supply Cord (optional sales)	MC-AC200A-2.0M (Only 2m length available)	※2	○
AC200V Power Supply Cord (optional sales)	MC-AC200B-2.0M (Only 2m length available)	※3	x
AC100V Power Supply Cord (optional sales)	MC-AC200B-2.0M (Only 2m length available) with Mans Plug Adaptor (Attached to the tip of AC Plug)	※4	x
External Connector & Cable (optional sales)	MC-EXC-02 (length:2m, output side unattached)	※1	○
Installation bracket (optional sales)	LBK-001 (Bottom type)		—

※1 Please inquire to MORITEX about cable different in length.

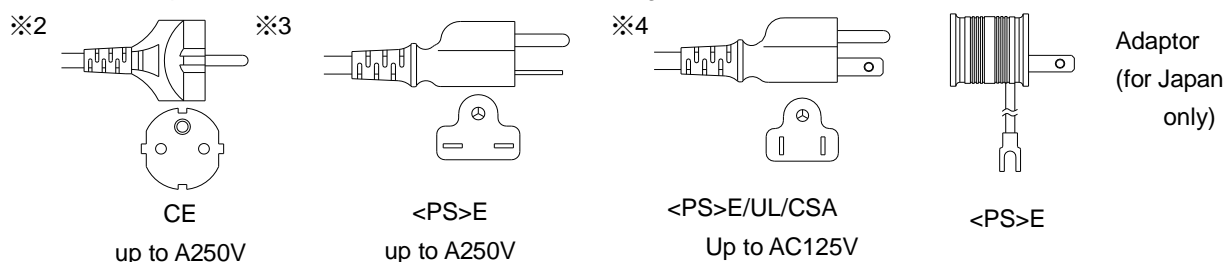

(Please check conforming to the relevant standards of country or area where you use cord.)

(Please inquire to MORITEX about specifications of Power Supply Cord.)

※5 An extension cable of 3m is not the adaptation of CE.

Dimensions

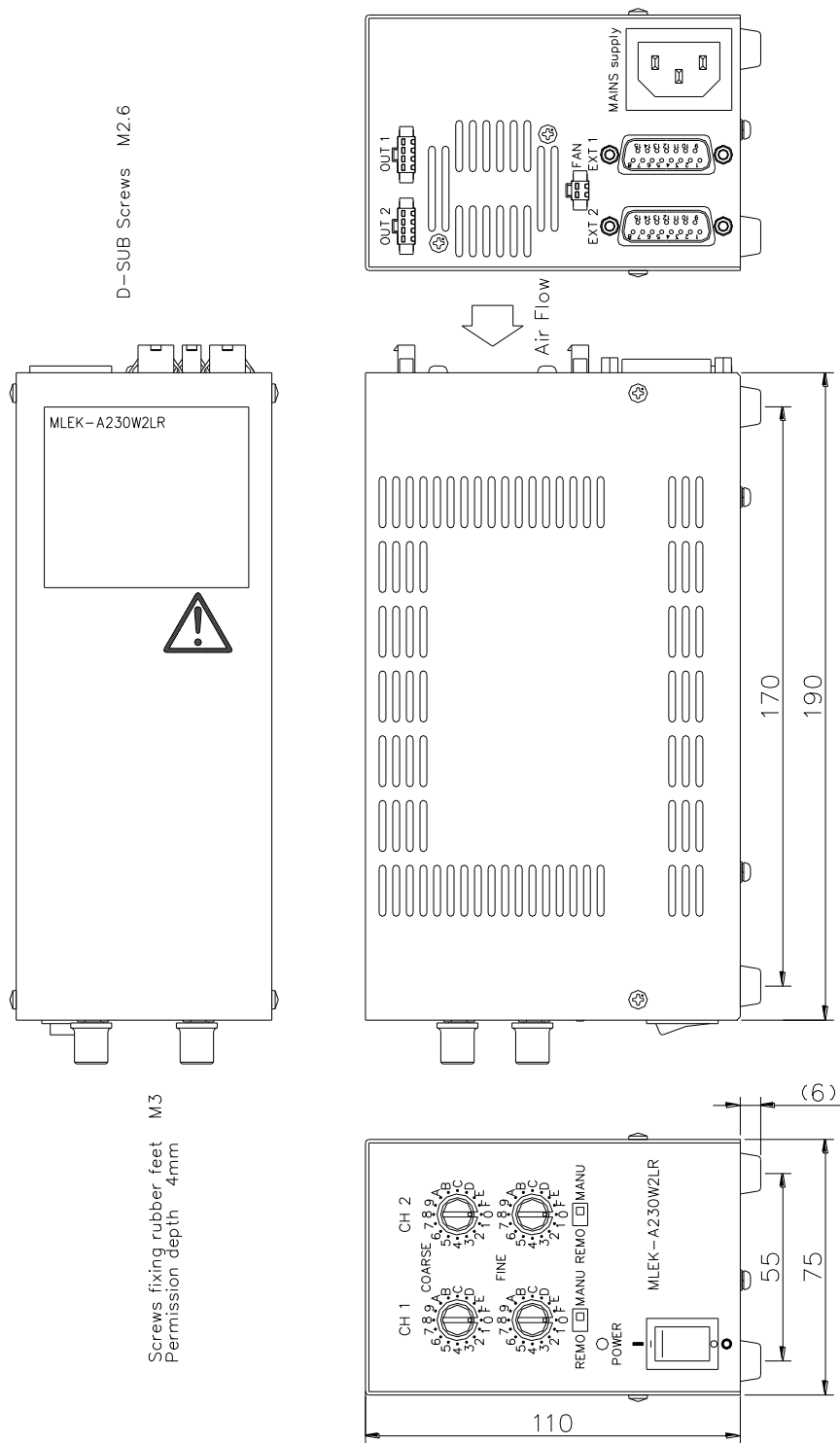

The drawings show the MLEK-A230W2LR unit.

MLEK-A080W2LR does not have Cooling Fan, Connector for Fan of Illuminator (FAN) and air holes on the back of the unit.

7. Others

1. Do not dispose equipment and/or parts of the equipment as unsorted municipal waste but collect them separately.
2. Before disposal of the equipment and/or parts of it, please contact MORITEX for any return or disposal methods/systems.
3. This symbol indicates separate collection of electrical and electronic equipment. Do not dispose equipment and/or parts of the equipment as unsorted municipal waste.



4. The equipment will be treated according to Directive 2012/19/EU (WEEE: Waste Electrical and Electronic Equipment). It is of highest importance to preserve, protect the quality of the environment, protect human health and to utilise natural resources prudently and rationally. Please be aware that it is also your responsibility to act in this sense, by disposing the equipment and/or parts of the equipment according to this Instruction Manual.

《Appendix》

- If there are any unclear points or if you have any questions, please feel free to inquire MORITEX.
For repair or after sales service, please contact any MORITEX office or the sales office where you have purchased the unit.
- Please provide following information when requesting service.

Model	:	MLEK-A080W2LR / MLEK-A230W2LR
Ser. No.	:	Indicated on the product
Date of purchase	:
State of trouble	:	Please provide detailed information
Your name (company name and/or individual name), address, telephone/FAX number, email-address	:	

お問い合わせは…….

株式会社 モリテックス

国内営業部 マシンビジョン営業

TEL 048-218-2534 / FAX 048-462-6714

代理店営業

TEL 048-218-2535 / FAX 048-462-6714

〒351-0024 埼玉県朝霞市泉水 3-13-45

URL : www.moritex.co.jp

For inquiry, please contact to:

MORITEX Corporation

3-13-45, Senzui, Asaka-shi,

Saitama 351-0024

Japan

Phone : +81-(0)48-218-2546

Fax : +81-(0)48-462-6713

E-mail : moritex.sales@moritex.com

URL : www.moritex.co.jp

: www.moritex.com

MORITEX Technologies

20# Guiyue Road Daping Village,

Guanlan Baoan District

Shenzhen, 518110

China,P.R.

Phone : +86 (0)755-2798-8282

Fax : +86 (0)755-2798-8575

E-mail : sales.china@moritex.com

URL : www.moritex.com

MORITEX North America, Inc.

6862 Santa Teresa Blvd.

San Jose, CA 95119 USA

Phone : +1-(0)408-363-2100

Fax : +1-(0)408-363-9980

E-mail : machine.vision@moritex.com

URL : www.moritex.com

Moritex Asia Pacific Pte. Ltd.

60, Benoi Road

#03-02 EMS Building

Singapore 629906

Phone : +65-(0)6264-0028

Fax : +65-(0)6264-8122

E-mail : sales.AP@moritex.com

URL : www.moritex.com