

Absolute Max. Rating / 最大定格	0.7 A
Total Power / 消費電力合計	3.0 W

CN1	Assign / 信号
1	+V
2	NC
3	-V

ILLUMINATION ANGLE ADJUSTING SCREW
M2 HEX SOCKET HEAD CAP(4x90°)
照明角度調整用ねじ
M2 六角穴付きボルト(4x90°)

SHIM ADJUSTMENT AND LED LOCK SCREW
M2 HEX SOCKET HEAD CAP(3x120°)
シム調整及びLED固定用ねじ
M2 六角穴付きボルト(3x120°)

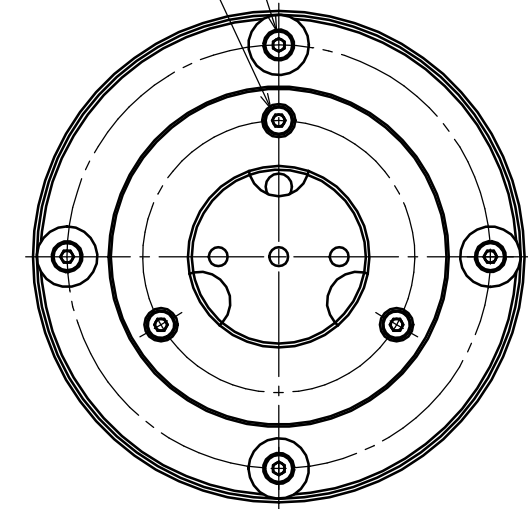
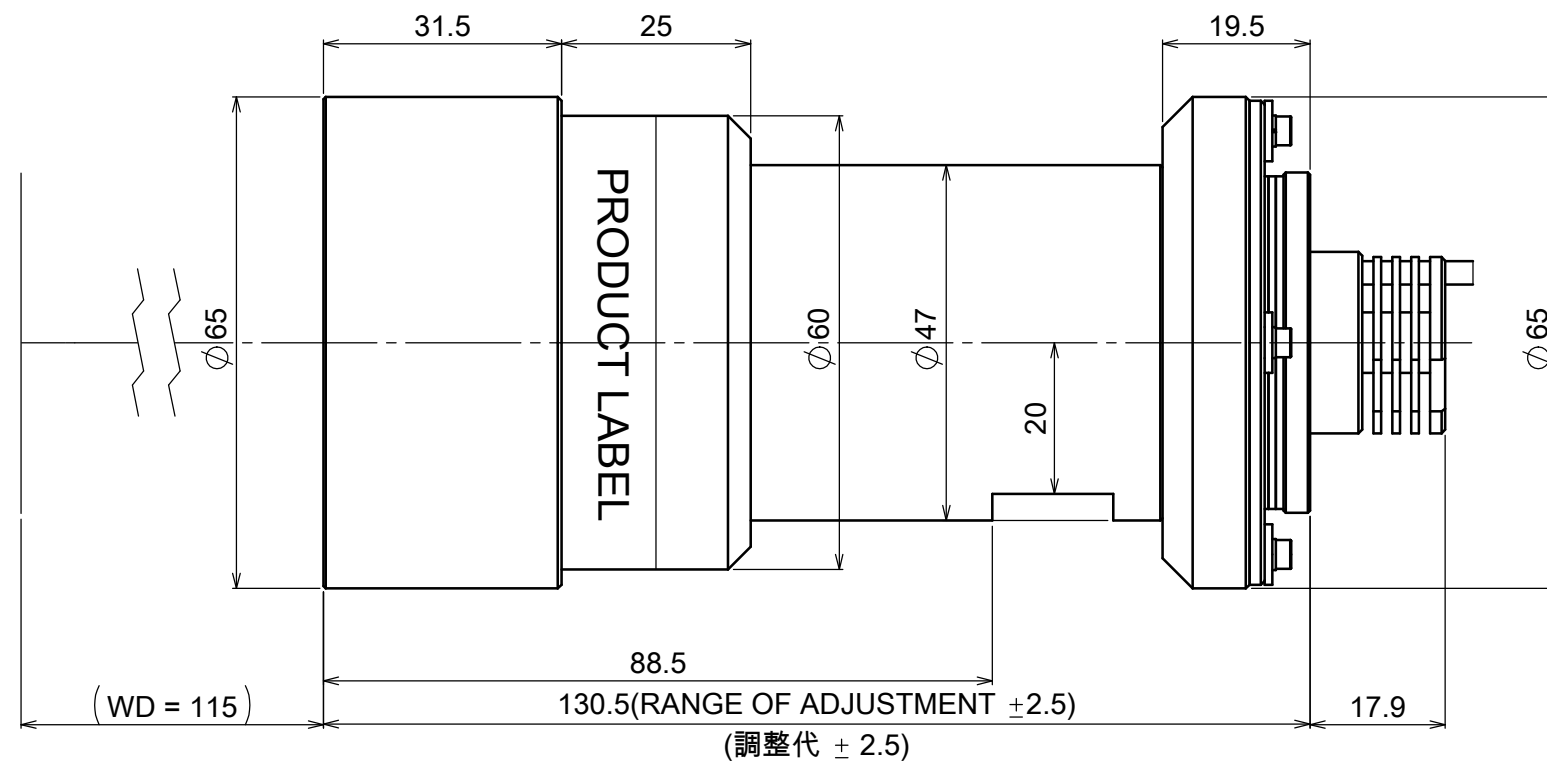

MOUNTING PORTION
DETAIL VIEW

フランジ取付部詳細

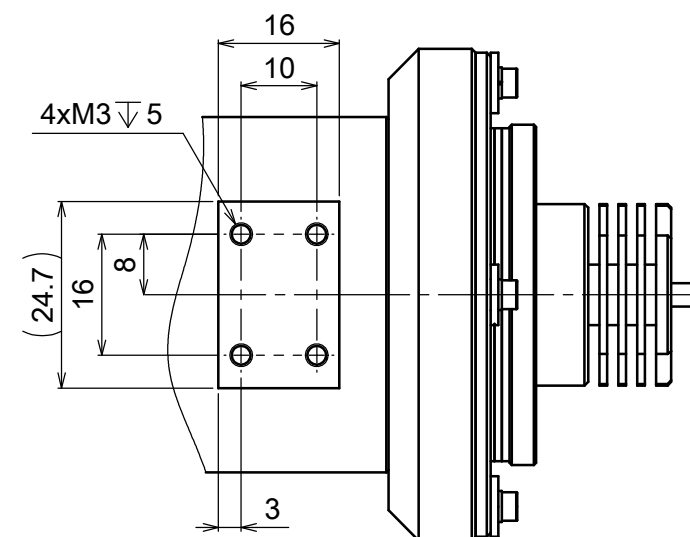

Model Name : MTI-45-CG-070
MORITEX CORPORATION